

NOT FOR NEW DESIGNS. Contact Marketing  
Manager for recommended alternatives.



RF1126

Broadband Medium Power SPDT Switch

## Product Overview

The RF1126 is a single-pole double-throw (SPDT) switch designed for general purpose switching applications which require very low insertion loss and medium power handling capability. The RF1126 is ideally suited for battery operated applications requiring high performance switching with very low DC power consumption. The RF1126 features low insertion loss, high linearity, and very good harmonic characteristics, and is operable from 1.8 V to 3.6 V control voltage. It is fabricated with 0.5  $\mu\text{m}$  GaAs pHEMT process, and is packaged in a very compact 2 mm x 1.3 mm, 6-pin, leadless QFN package.

## Functional Block Diagram

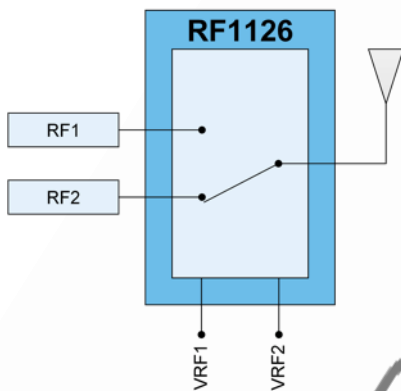

Functional Block Diagram



Package Style: QFN, 6-pin, 2 mm x 1.3 mm x 0.35 mm

## Key Features

- Broadband performance low frequency to 5.8 GHz
- Very Low Insertion Loss  
0.26 dB Typ at 1 GHz  
0.32dB Typ at 2 GHz
- Excellent harmonics < -75 dBc at 2 GHz
- High IIP3: Cell Band Typ. 62 dBm
- 1.8 V capable for low power Applications
- P0.1 dB > 23 dBm Typ @ 2 GHz

## Applications

- Cellular Handset Applications
- Antenna Tuning Applications
- IEEE802.11b/g WLAN Applications
- Multi-mode GSM, W-CDMA Applications
- WLAN Applications

## Ordering Information

Part Number	Description
RF1126	Broadband Medium Power SPDT Switch
RF1126PCBA-410	Fully Assembled Evaluation Board



NOT FOR NEW DESIGNS. Contact Marketing

Manager for recommended alternatives.

RF1126

Broadband Medium Power SPDT Switch

### Absolute Maximum Ratings

Parameter	Rating	Unit
Voltage	6.0	V
Maximum input power (0.6 GHz to 2.5 GHz), RF1, RF2	+28	dBm
Operating temperature	-30 to +85	°C
Storage temperature	-65 to +100	°C

Exceeding any one or a combination of the Absolute Maximum Rating conditions may cause permanent damage to the device. Extended application of Absolute Maximum Rating conditions to the device may reduce device reliability. Specified typical performance or functional operation of the device under Absolute Maximum Rating conditions is not implied.

Parameter	Specification			Unit	Condition
	Min.	Typ.	Max.		
Overall – $V_{\text{control\_high}} = 3\text{ V}$					$V_{\text{RF1}}, V_{\text{RF2}} = \text{High} = 3\text{ V}, V_{\text{RF1}} = V_{\text{RF2}} = \text{Low} = 0\text{ V}, \text{Temp} = 25\text{ }^\circ\text{C}$
Operating Frequency	33		5800	MHz	
<b>Insertion Loss</b>					
RFC – RF1, RFC – RF2		0.21	0.24	dB	RF ON, 50 MHz to 450 MHz
		0.26	0.31	dB	RF ON, 824 MHz to 960 MHz
		0.32	0.40	dB	RF ON, 1850 MHz to 1990 MHz
		0.36	0.45	dB	RF ON, 2170 MHz to 2500 MHz
		0.70		dB	RF ON, 5.8 GHz
<b>Isolation</b>					
RFC – RF1, RFC – RF2	31	33		dB	RF ON, 450 MHz
	25	27		dB	RF ON, 824 MHz to 960 MHz
	18	20		dB	RF ON, 1850 MHz to 1990 MHz
	16	19		dB	RF ON, 2170 MHz to 2500 MHz
			11	dB	RF ON, 5.8 GHz
Return Loss	19	26		dB	500 MHz to 3000 MHz
Second Harmonic		75		dBc	$P_{\text{IN}} = +15\text{ dBm}$ , 1980 MHz
		69		dBc	$P_{\text{IN}} = +15\text{ dBm}$ , 2500 MHz
Third Harmonic		90		dBc	$P_{\text{IN}} = +15\text{ dBm}$ , 1980 MHz
		70		dBc	$P_{\text{IN}} = +15\text{ dBm}$ , 2500 MHz
<b>IIP3</b>					
RF1 – RFC, RF2 – RFC (Cell)	61	62		dBm	Tone 1: 836.5 MHz @ 16 dBm, Tone 2: 791.5 MHz @ -20 dBm Rx Freq: 881.5 MHz
RF1 – RFC, RF2 – RFC (IMT)	59	60		dBm	Tone 1: 1950 MHz @ 16 dBm, Tone 2: 1760 MHz @ -20 dBm Rx Freq: 2140 MHz
<b>Triple Beat Ratio</b>					
Cell/AWS/PCS		61		dBc	VSWR = 2:1
0.1 dB Compression (P0.1 dB)	21	23		dBm	500 MHz to 3000 MHz
Switching Speed		160	400	ns	50% control to 10%/90%
Control Current		0.4	1.0	µA	$P_{\text{IN}} = 15\text{ dBm}$



NOT FOR NEW DESIGNS. Contact Marketing

Manager for recommended alternatives.

RF1126

Broadband Medium Power SPDT Switch

Parameter	Specification			Unit	Condition
	Min.	Typ.	Max.		
Overall – $V_{\text{control\_high}} = 1.8 \text{ V}$					$V_{\text{RF1}}, V_{\text{RF2}} = \text{High} = 1.8 \text{ V}, V_{\text{RF1}} = V_{\text{RF2}} = \text{LOW} = 0 \text{ V}, \text{Temp.} = 25 \text{ }^\circ\text{C}$
Operating Frequency	50		5800	MHz	
<b>Insertion Loss</b>					
RFC – RF1, RFC – RF2		0.21	0.30	dB	RF ON, 450 MHz
		0.26	0.35	dB	RF ON, 824 MHz to 960 MHz
		0.32	0.45	dB	RF ON, 1850 MHz to 1990 MHz
		0.36	0.50	dB	RF ON, 2170 MHz to 2500 MHz
		0.70		dB	RF ON, 5.8 GHz
<b>Isolation</b>					
RFC – RF1, RFC – RF2	30	32		dB	RF ON, 450 MHz
	24	25		dB	RF ON, 824 MHz to 960 MHz
	17	19		dB	RF ON, 1850 MHz to 1990 MHz
	15	18		dB	RF ON, 2170 MHz to 2500 MHz
		11		dB	RF ON, 5.8 GHz
Return Loss	19	26		dB	500 MHz to 3000 MHz
0.1 dB Compression (P0.1 dB)	7	11		dBm	500 MHz to 3000 MHz
Switching Speed		160	400	ns	50% control to 10%/90%
DC Supply	1.8	3.0	3.6	v	VRF1 and VRF2 (H)
	0		0.4	v	VRF1 and VRF2 (L)
Control Current		0.4	1.0	$\mu\text{A}$	$P_{\text{IN}} = 15 \text{ dBm}$

## Control Logic

	Control Signals		Signal Paths	
	$V_{\text{RF1}}$	$V_{\text{RF2}}$	RF1 – RFC	RF2 – RFC
Valid States	1	0	ON	OFF
	0	1	OFF	ON
Invalid States	0	0	Indeterminate State*	
	1	1	Indeterminate State*	

0: Logic level low, 0 V ~ 0.4 V

1: Logic level high, 1.8 V ~ 3.6 V

Note: In indeterminate states, both signal paths are ON with degraded performance.

Pin	Function	Description
1	RF1	RF Port 1
2	GND	Ground
3	RF2	RF Port 2
4	VRF2	Control 2
5	RFC	Antenna
6	VRF1	Control 1
Pkg Base	GND	Ground

Package Drawing

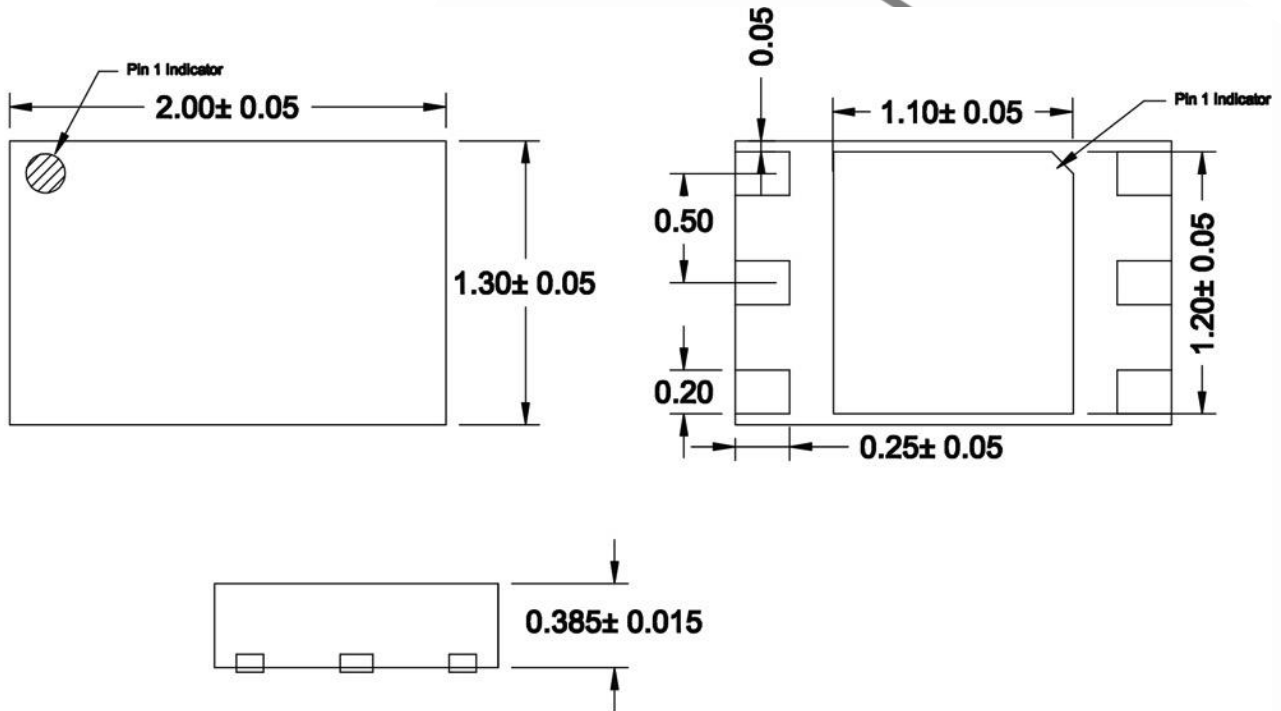

Notes:

- 1) Pin 1 Indicator Shaded Area

Evaluation Board Schematic

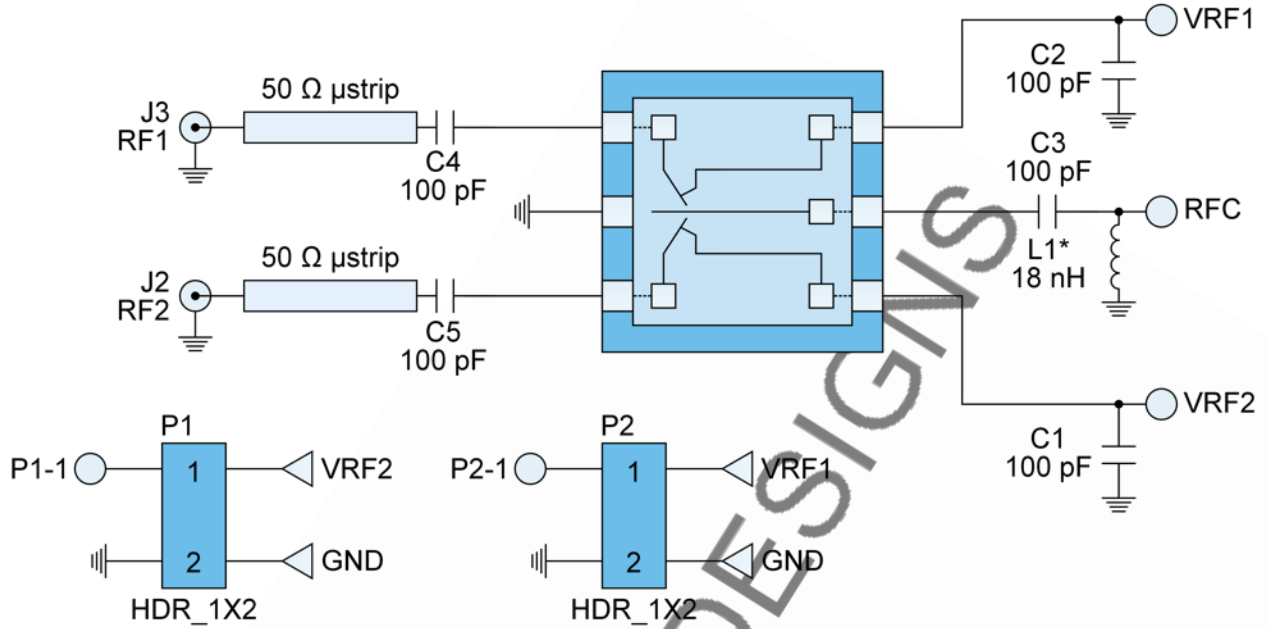

\*L1 is optional for IEC61000-4-2 ESD protection.

NOT FOR NEW DESIGNS



NOT FOR NEW DESIGNS. Contact Marketing

Manager for recommended alternatives.

RF1126

Broadband Medium Power SPDT Switch

## Evaluation Board Layout

Board Thickness 0.067", Board Material FR-4, Multi-layer

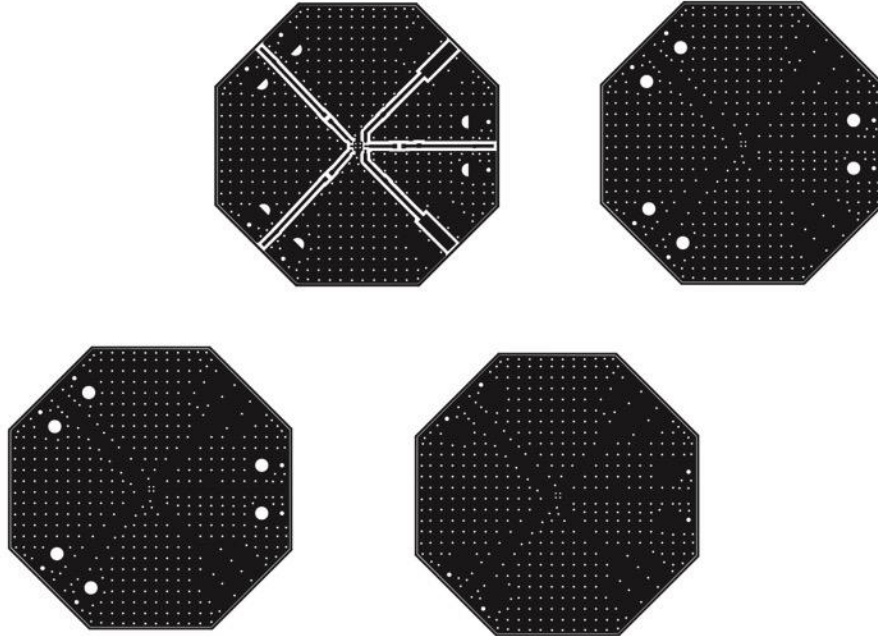

NOT FOR NEW



NOT FOR NEW DESIGNS. Contact Marketing

Manager for recommended alternatives.

RF1126

Broadband Medium Power SPDT Switch

Typical Performance Data on Evaluation Board Note: Fixture losses have been de-embedded  
(Temp. = 25 °C,  $V_{RF1} = V_{RF2} = \text{High} = 3 \text{ V}$   $V_{RF1} = V_{RF2} = \text{Low} = 0 \text{ V}$ )

**Insertion Loss**  
(Temp. = 25 °C,  $V_{RF}(H) = 3 \text{ V}$ )

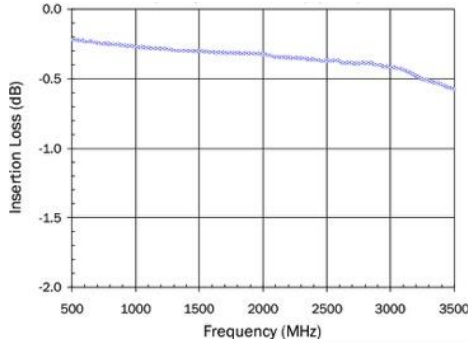

**Return Loss**  
(Temp. = 25 °C,  $V_{RF}(H) = 3 \text{ V}$ )

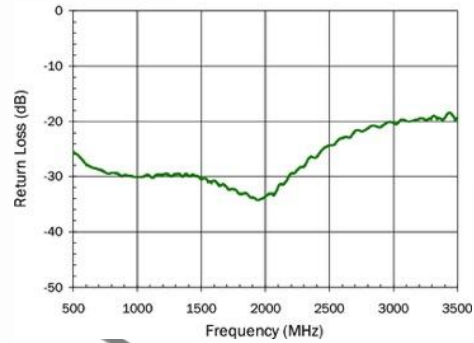

**Isolation (Ant - RF port)**  
(Temp. = 25 °C,  $V_{RF}(H)=3 \text{ V}$ )

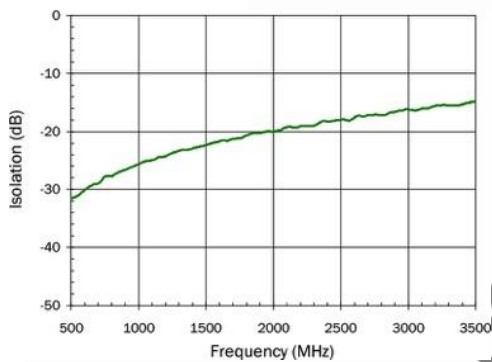

**Isolation (Port - Port)**  
(Temp. = 25 °C,  $V_{RF}(H) = 3 \text{ V}$ )

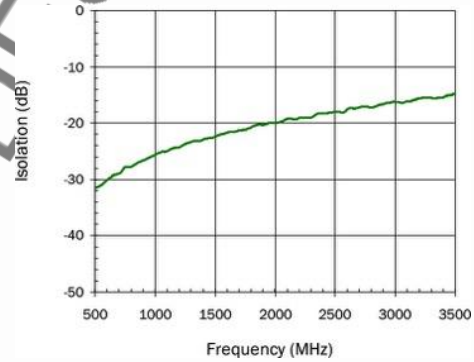

**Output Power versus Input Power**  
(Temp. = 25 °C, Frequency = 1980 MHz,  $V_{CTL}(H) = 3 \text{ V}$ )

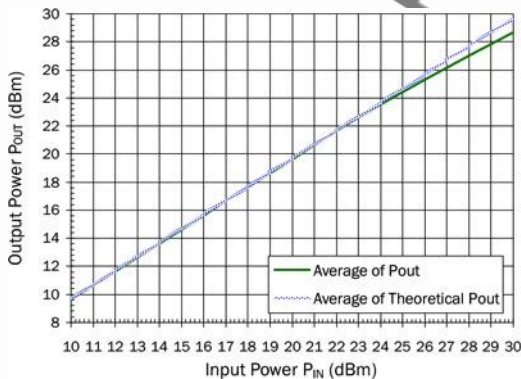

**Harmonics**  
(Temp. = 25 °C,  $V_{RF}(H) = 3 \text{ V}$ )

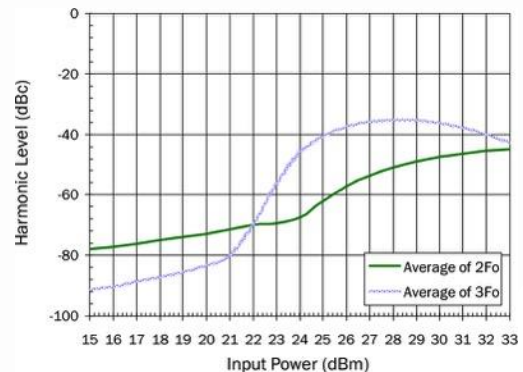



NOT FOR NEW DESIGNS. Contact Marketing

Manager for recommended alternatives.

RF1126

Broadband Medium Power SPDT Switch

## Solderability

---

Compatible with both lead-free (260 °C max. reflow temperature) and tin/lead (245 °C max. reflow temperature) soldering processes.  
Package lead plating: -Matte Sn

## RoHS Compliance

---

This part is compliant with the 2011/65/EU RoHS directive (Restrictions on the Use of Certain Hazardous Substances in Electrical and Electronic Equipment), as amended by Directive 2015/863/EU.

This product also has the following attributes:

- Lead free
- Halogen Free (Chlorine, Bromine)
- Antimony Free
- TBBP-A (C<sub>15</sub>H<sub>12</sub>Br<sub>4</sub>O<sub>2</sub>) Free
- SVHC Free



NOT FOR NEW DESIGNS





NOT FOR NEW DESIGNS. Contact Marketing

Manager for recommended alternatives.

RF1126

Broadband Medium Power SPDT Switch

## REVISION HISTORY

REVISION	DESCRIPTION
DS110405	Release version
DS140709	Revised minimum operating frequency from 50 MHz to 33 MHz
DS20170308	Converted from RFMD to Qorvo template
E (20180508)	Added Not For New Design marking

## Contact Information

For the latest specifications, additional product information, worldwide sales and distribution locations:

**Web:** [www.qorvo.com](http://www.qorvo.com)

**Tel:** 1-844-890-8163

**Email:** [customer.support@qorvo.com](mailto:customer.support@qorvo.com)

## Important Notice

The information contained herein is believed to be reliable; however, Qorvo makes no warranties regarding the information contained herein and assumes no responsibility or liability whatsoever for the use of the information contained herein. All information contained herein is subject to change without notice. Customers should obtain and verify the latest relevant information before placing orders for Qorvo products. The information contained herein or any use of such information does not grant, explicitly or implicitly, to any party any patent rights, licenses, or any other intellectual property rights, whether with regard to such information itself or anything described by such information. **THIS INFORMATION DOES NOT CONSTITUTE A WARRANTY WITH RESPECT TO THE PRODUCTS DESCRIBED HEREIN, AND QORVO HEREBY DISCLAIMS ANY AND ALL WARRANTIES WITH RESPECT TO SUCH PRODUCTS WHETHER EXPRESS OR IMPLIED BY LAW, COURSE OF DEALING, COURSE OF PERFORMANCE, USAGE OF TRADE OR OTHERWISE, INCLUDING THE IMPLIED WARRANTIES OF MERCHANTABILITY AND FITNESS FOR A PARTICULAR PURPOSE.**

Without limiting the generality of the foregoing, Qorvo products are not warranted or authorized for use as critical components in medical, life-saving, or life-sustaining applications, or other applications where a failure would reasonably be expected to cause severe personal injury or death.

Copyright 2017 © Qorvo, Inc. | Qorvo is a registered trademark of Qorvo, Inc.